

SMART AND SIMPLE SYSTEM FOR DENTAL LAB AND PRACTICE

The largest consumable system range in the world
with the exceptional quality.

ARUM Implant Prosthetic Component

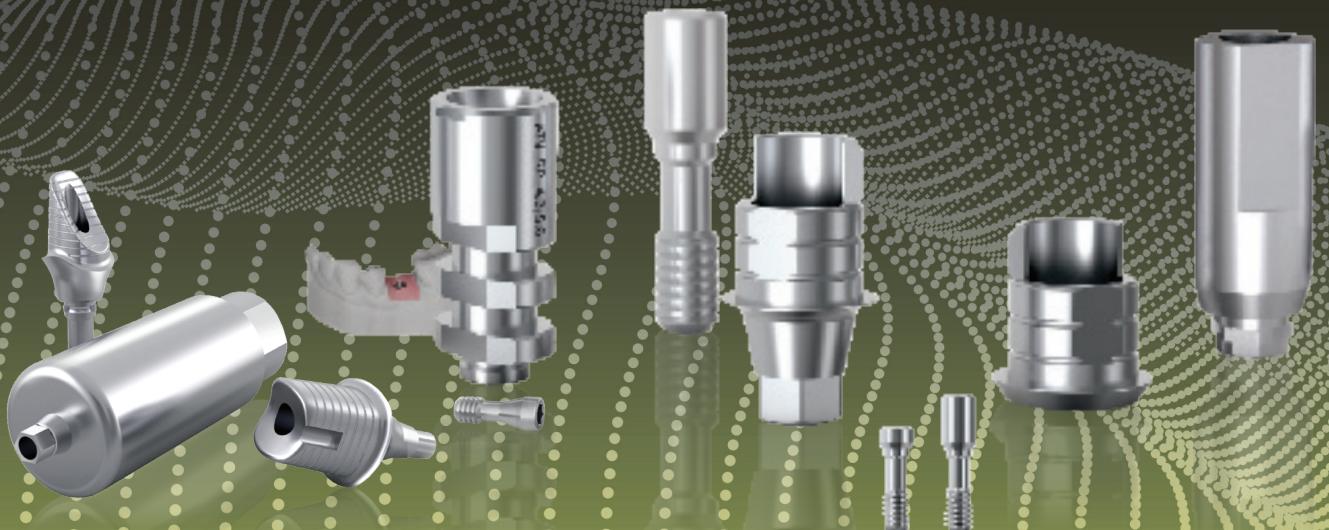

ARUM

Consumable Line-up

New system is updated regularly.
Please check the latest at our e-shop, www.arumdentalshop.com

A series	Compatible with	E series	Compatible with	N series	Compatible with
AB-IH	Alpha-Bio Tec® Internal Hex	EB	EBI®	NEB	NEOBIOTECH®
AD-CLOS	ADIN® CLOSEFIT™	EU-AT	EUROTEKNIKA™ Aesthetica	NED-CM	NEODENT®CM
AD-TOU	ADIN® TOUAREG™ S&OS	EU-IN	EUROTEKNIKA™ Internal Naturactis/Naturall+/Natea+	NED-EXT	NEODENT® EXTERNAL
AN	ANTHOGYR® Axiom	G series	Compatible with	NED-GM	Neodent® GM
AT-EV	ASTRA TECH™ OsseoSpeed™ EV	GLD-TEK	Global D® Tekka® In-Kone®	NOS-PA	NEOSS Pro Active®
AT-EVPRO	ASTRA TECH™ OsseoSpeed™ Profile EV	H series	Compatible with	NB-ACT	NOBEL BIOCARE® Active™
AT-OSS	ASTRA TECH™ OsseoSpeed™ TX	HMT-RA	HumanTech RATIO	NB-BRA	NOBEL BIOCARE® Branemark®
B series	Compatible with	I series	Compatible with	NB-REP	NOBEL BIOCARE® Replace Select™
BEG	BEGO®	ID-LEG	IMPLANT DIRECT® Legacy™	NCOS	NucleOSS
BIC	BICON® Integra-CP™	ID-IAT	IMPLANT DIRECT® Inter Active	O series	Compatible with
BH-EXT	BIOHORIZONS® External®	ID-SAT	IMPLANT DIRECT® Swish Active	OST-GS	OSSTEM® GS(TS)
BH-INT	BIOHORIZONS® Internal®	ID-PLU	IMPLANT DIRECT® Swish Plus	OST-SS	OSSTEM® SS
BM3I-INT	BIOMET 3i® Certain®	ID-TRI	IMPLANT DIRECT® Tri Lobe	OST-US	OSSTEM® US
BM3I-EXT	BIOMET 3i® EXTERNAL	IL-GB	INTRA-LOCK® GOLD&BLUE™	P series	Compatible with
BT-BIK	BIOTECH®	J series	Compatible with	PLT-IV	PLATON® Type IV Pro
BB-MYT	BrainBase Corporation® MYTIS Arrow Implant	JD-EV	J DENTAL CARE® JD EVOLUTION®	S series	Compatible with
BRM-SK	BREDDENT Medical SKY®	JD-ICO	J DENTAL CARE® JD Icon®	SHN	SHINHUNG®
BT-INT	BTI INTERNA®	JD-OCT	J DENTAL CARE® JD EVOLUTION® Octa	SC-INV	SIC Invent®
BT-ENT	BTI EXTERNA®	JD-EVP	J DENTAL CARE® JD EVOLUTION® Plus	SI-DC	SOUTHERN IMPLANTS Deep Conical
C series	Compatible with	K series	Compatible with	SI-MSC	SOUTHERN IMPLANTS MSc External Hex
CAM	CAMLOG®	KENT	KENTEC®	SI-INT	SOUTHERN IMPLANTS M-Series (Internal Hex)
CL-CON	CLC Conic	KS-PRI	KEYSTONE Prima Connex®	SI-TRI	SOUTHERN IMPLANTS Tri Nex
CON	CAMLOG® CONELOG®	KYO-FBL	KYOCERA FINESIA® Bone Level	STR-BL	STRAUMANN® Conical Bone Level®
CRT	CORTEX™	KYO-PO	KYOCERA PoieX	STR-TL	STRAUMANN® synOcta®
CTE-EST	C-TECH® Esthetic Line	L series	Compatible with	SM-PK	Sweden&Martina Premium Kohno
CWM-INT	COWELLMEDI® INNO Internal	LSK-BIO	LASAK Bioniq®	SM-SH	Sweden&Martina Shelta
D series	Compatible with	M series	Compatible with	SM-PM	Sweden&Martina Prama
DP	DEEP®	MM-IC	Medentis Medical® ICX	T series	Compatible with
DR-TIO	Dentaurum tioLogic®	MEG	MEGAGEN®	TN-EXT	TITANIUM Fix External
DTS-ICL	DENTIS® i-Clean	MEG-ONE	MEGAGEN® AnyONE	THO-SPI	THOMMEN SPI®
DTS-SCL	DENTIS® s-Clean	MEG-RID	MEGAGEN® Anyridge	TR-NI	TRI® Narrow Implants
DTM-NR	DENTIUM® NR Line	MEG-EEP	MEGAGEN® Anyridge® Extra EZ POST	TR-OCT	TRI® Octa
DTM-SIM	DENTIUM® SimpleLine	MEG-EZP	MEGAGEN® EZ Plus	TR-VN	TRI® Vent
DTM-SPL	DENTIUM® SuperLine	MEG-MIN	MEGAGEN® Mini	W series	Compatible with
DS-ANK	DENTSPLY® Ankylos® C/X Implant	MEG-RES	MEGAGEN® Rescue	WAR-ONE	WARANTEC® Oneplant
DS-XIV	DENTSPLY® XIVE	MS-C	MIS® C1	Z series	Compatible with
DO-SM	DIO® SM	MS-INT	MIS® Internal Hexagon	ZIA	ZIACOM®
DO-UF	DIO® UF I & II Internal Submerged			ZMR-EZT	ZIMMER® Eztetic
DO-UFNS	DIO® UF II Internal Non Submerged			ZMR-SP	ZIMMER® Swiss Plus
DYN-PUS	DYNA Pushin Octalock			ZMR-SPA	ZIMMER® Spline A
				ZMR-SPB	ZIMMER® Spline B
				ZMR-TSV	ZIMMER® Tapered Screw-Vent®

ARUM Dental Online Shop

- Ti-base, Lab Analog, Premilled Blank, Clinical Screw, Scanbody, Tool & Part and Dental CAD/CAM Material
- Over 500 compatible implant systems
- More than 3,000 component products
- Easy product search through multi-filtering
- EN/DE/FR 3 language support online shop
- Mobile Shop is ready - iOS / Android

www.arumdentalshop.com

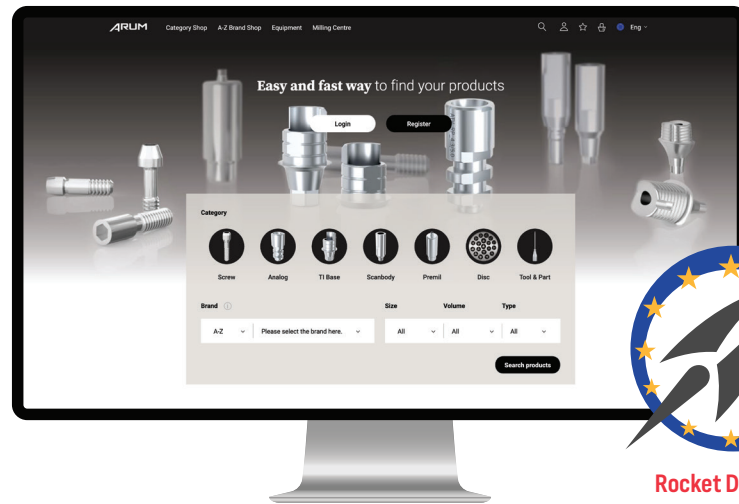

ARUM Dental Shop Application

*Dental Shop
at your finger tip!*



Download App Here!



Angled Ti-base

- Raw Material Ti 6Al-4V ELI (ASTM F 136) Supplied by Germany
- Industry's largest implant system compatibility
- Superior level of biocompatibility
- Combination of high fatigue strength

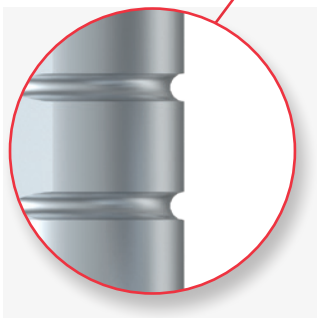
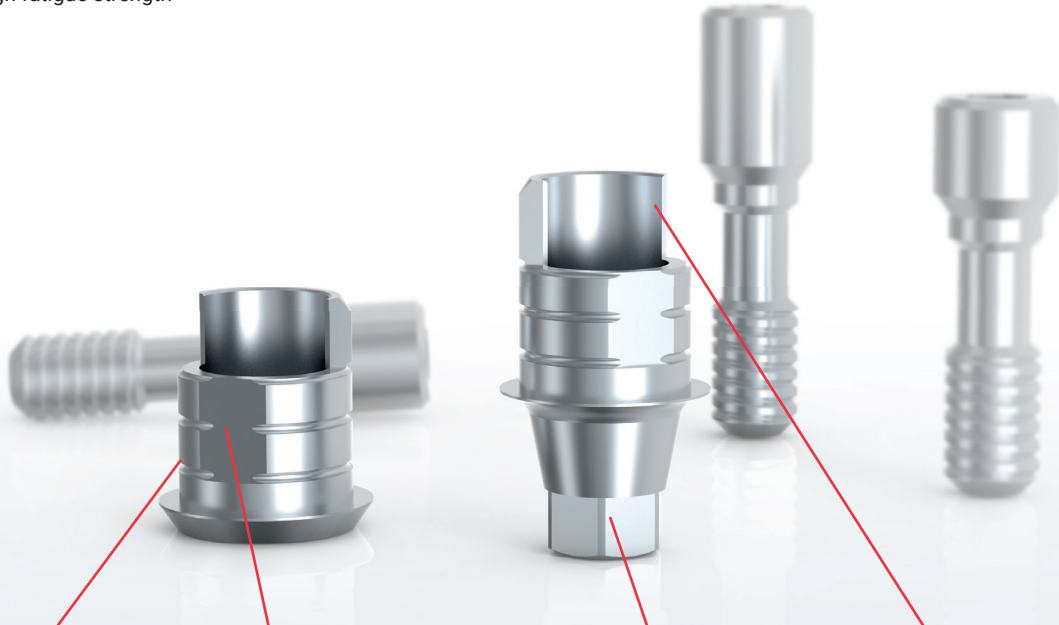

Exterior retentions for more cementation bonding

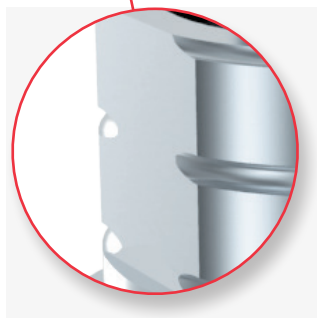

The cut side surface and hex part surface in the image are same direction

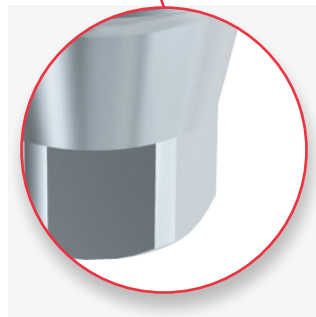

Precision machined up to $\pm 5\mu\text{m}$

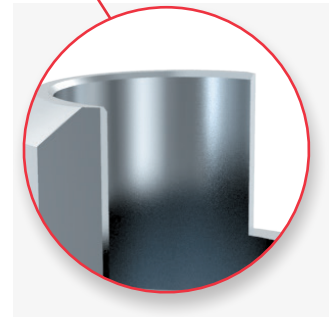

Prevention of zirconia rotation

2 Clinical Screws Included



Straight Screw

Same as the original screw design

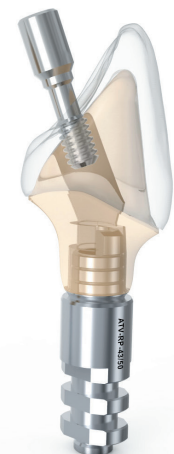

Angled Screw

- Raw Material Stainless Steel 303F
- Industry's largest implant system compatibility
- Precision machined up to $\pm 5\mu\text{m}$
- For 3D print & Stone model

ARUM Identification Code

compatible with
NOBEL BIO CARE® Active™ RP 4.3/5.0

ATV-RP-43/50

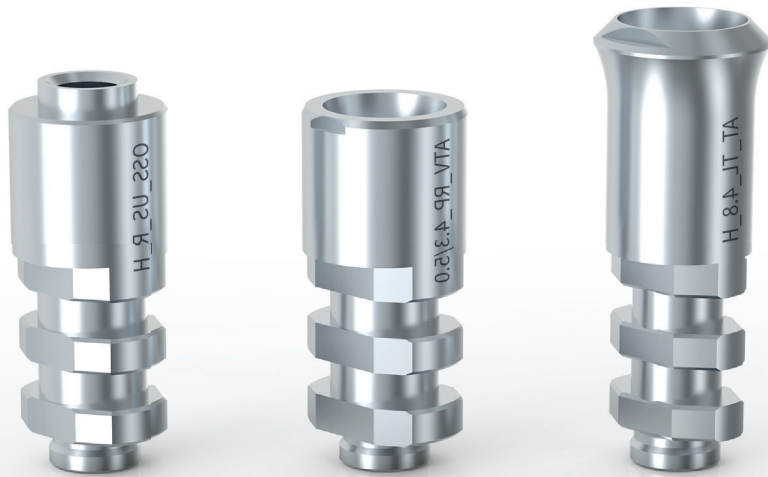

Stone Model

3D Print Model



Position Indicator
3D print & stone model

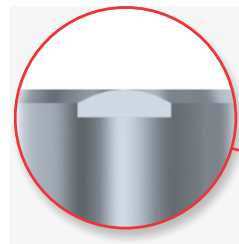

Antirotate Design



Level Stopper
for 3D print model &
stone model

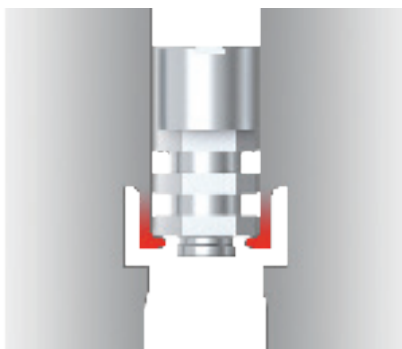
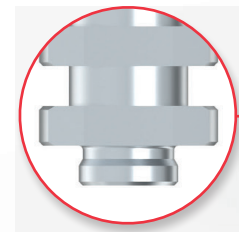

3D Print Model
with Click System

Pre-milled Blank

- Raw Material Ti 6Al-4V ELI (ASTM F 136) Supplied by Germany
- Industry's largest implant system compatibility
- Securement of quality through full-scale inspection
- Precision machined up to $\pm 5\mu\text{m}$
- Diameter 10mm, 14mm

2 Clinical Screws Included

- Same as the original screw design



Diameter 10mm,14mm

We provide diameter of 10 and 14 mm for you to make Customized Abutments appropriate for various conditions of teeth. As they are compatible with more than 500 implant systems, you can machine using ARUM equipment.

Attachment

With use of Attachment, you can machine more sophisticated and near-perfect Customized Abutment.

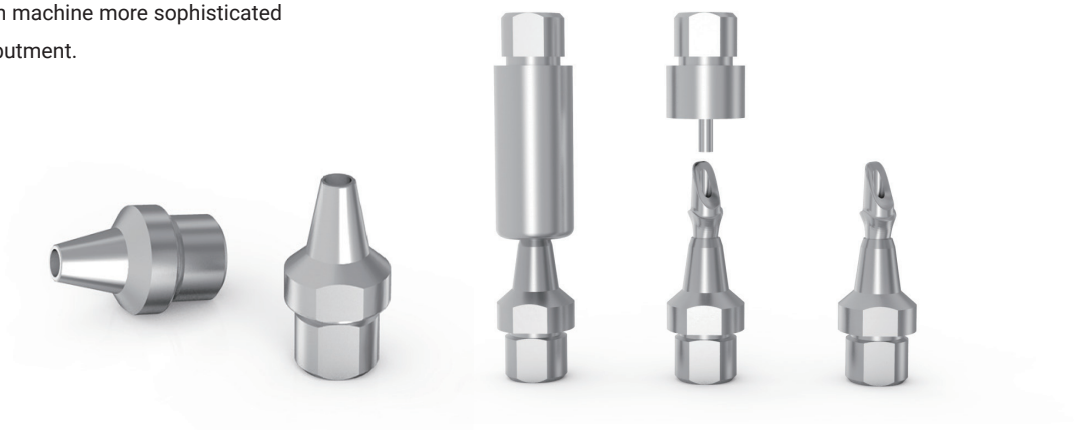

Healing Scanbody

- Raw Material Ti 6Al-4V ELI (ASTM F 136) Supplied by Germany
- Accurate tightening indicator "A Line"
- Easy and fast scan data matching
- Minimal gingival pressure and securement of gingiva



A Line

Indexes for the accurate fastening of implant fixtures and oral scan bodies and the prevention of the rotation of customised abutments.

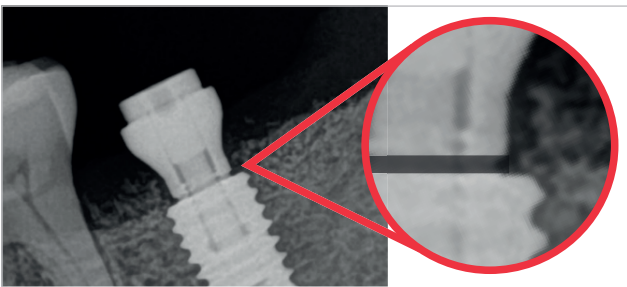

Easy and accurate matching

Easy and accurate scan data and library matching by nuts, D-cut and slope.

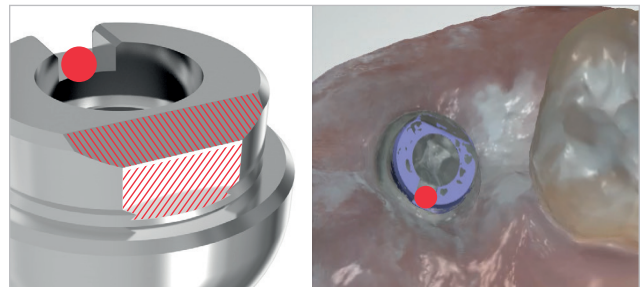

Concave Line

Concave Line to increase the completeness of dental procedure. Minimization of gingival pressure. Securement of thick gingiva.

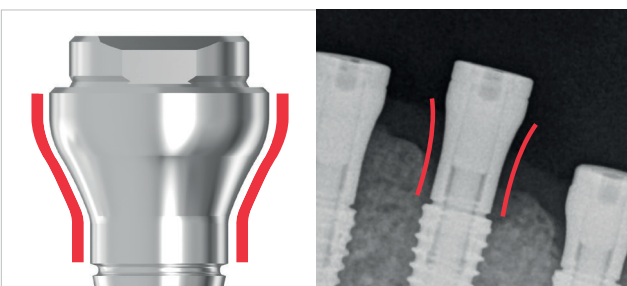

Healing Scanbody Holder

Easy connect to fixture with intraoral scanbody holder. It is good for the complex case like molar procedure. Possibility to select a suitable size with each different oral cavity.

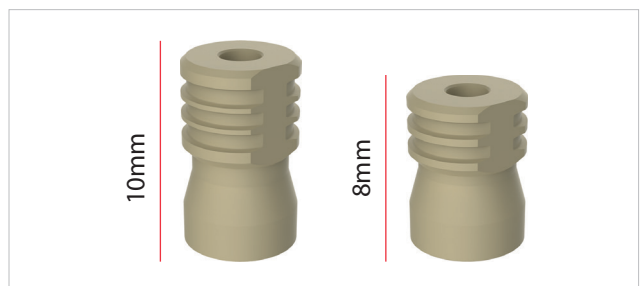

Model / Intraoral Scanbody

- Raw Material Stainless Steel 303F
- Supports with the industry's largest number of implant systems and libraries



Free Library setup by remote support

ARUM technical support team will securely setup the library files into your PC through a remote connection to start your design right away.

800+

 Implant Connections

exocad

3shape

dental wings

High Accuracy



WHY

Arum scanbodies are **METAL?**

In comparison to PEEK, one can always rely on the exceptional precision and unparalleled wear-resistance from the metal scanbody.

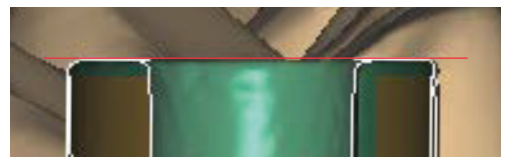

Arum Metal Scanbody

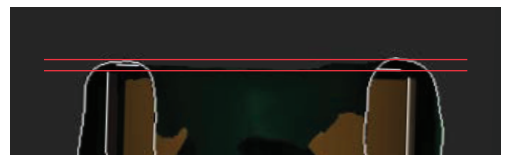

PEEK / Soft Material Scanbody

Screw

- Raw Material Ti 6Al-4V ELI (ASTM F 136) Supplied by Germany
- All hand inspection of thread
- Industry's largest implant system compatibility
- Precision and intensity of illumination
- Implement inspection with 150% value of original torque
- Same as the original screw design



Clinical Driver

- Use of Trimrite with excellent corrosion resistance
- Easy and simple cleaning
- For angled screw channels
- Heat treatment and hardness of 50 or more



Clinical Screw Driver tip (Machining type)

Ball Torx - 25mm

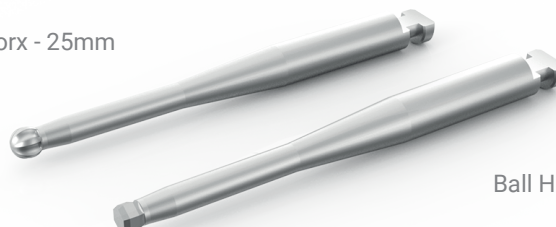

Ball Hex - 25mm

Lab Driver



Screw Driver Tips

- Place the model scanbody and the abutment
- 10 types of tips (compatible with the various implant systems)



Analog Insertion Tips

- Place the lab analog to 3D printed model
- Easy and safe to place the lab analog
- Prevent damage of the lab analog internal thread
- 5 types of tips (compatible with the various implant systems)













Torque Adapter



- For clamping Attachment and Premill for connectorless milling (with 0.4Nm torque)
- Prevent screw loosening during milling



Screw Driver Tips Line-Up

SIZE	COLOR	Compatible Implant System
 Hex 1.0	Blue	DENTIUM® NR Line / DENTSPLY® Ankylos® C/X Implant etc
 Hex 1.2	Purple	ADIN® TOUAREG™ S&OS/ANTHOGYR ANTHOFIT / BIOMET 3i®Certain/ BIOMET 3i® EXTERNAL HEX / BTI INTERNAL® / COWELLMEDI® INNO Internal / DENTIS® i-Clean / DENTSPLY® Xive® / DIO®UF / Global D® Tekka® In-Kone / MEGAGEN® AnyONE / MEGAGEN® Anyridge® / MEGAGEN® Anyridge® MEGAGEN®Extra EZ POST / MEGAGEN® EZ Plus / MEGAGEN® Rescue /NEOBIOTECH® / OSSTEM® GS(TS) /OSSTEM® SS / OSSTEM® US / SHINHUNG® / SIC Invent®/SOUTHERN IMPLANTS MSc EXTERNAL HEX / WARANTEC®Oneplant etc
 Hex 1.25	Black	BEGO® Semados/ BIOHORIZONS® External® / BIOHORIZONS® Internal® / DENTIS® s-Clean / LASAK Bioniq® etc.
 Hex 1.27	Red	ANTHOGYR AXIOM/Alpha-Bio Tec®Internal Hex / ASTRA TECH™ OsseoSpeed™ TX /CAMLO®CAMLO®/ CAMLOG®CONELOG® / CORTEX™ / DEEP® / DENTIUM® SimpleLine /DENTIUM® SuperLine / EBI®/ IMPLANT DIRECT®Legacy™ / MIS® C1 / MIS®Internal Hexagon./ ZIMMER®Spline A / ZIMMER®Spline B / ZIMMER®Tapered Screw-Vent® etc.
 Hex 1.3	Green	ASTRA TECH™ OsseoSpeed™ EV / CLC Conic / DYNA Pushin Octalock® / KENTEC® / PLATON® Type IV Pro / Sweden & Martina etc
 Torx 1.7	Brown	STRAUMANN® Bone Level ® / STRAUMANN® ConicalBone Level ® / STRAUMANN® synOcta® etc.
 Torx 1.5 (Star)	Yellow	ADIN® CLOSEFIT™ / NOBEL BIOCARE® Active™ / NOBEL BIOCARE® Branemark ® / NOBEL BIOCARE® Replace Select™ / NEOSS Pro Active® etc.
 Cross	Gray	THOMMEN SPI® etc
 Ball Torx	Orange	1. Most of angled screws of ARUM Ti-base (screw head size should be more than 2.1mm) 2. ALL IMPLANT SYSTEM FOR DISK ANGULATED SCREW CHANNELS
 Ball Hex	White	Some of angled screws of ARUM Ti-base (screw head size should be less than 2.1mm) *Please visit our website to see the list.

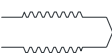
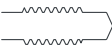
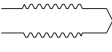
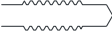
Analog Insertion Tips Line-Up

SIZE	COLOR	Compatible Implant System
 M2.0*P0.40	Cocoa	Osstem GS Regular, Dentium Super line, Megagen Anyone, Dentis S-clean, Straumann Tissue level, etc.
 M1.8*P0.35	Light Green	Zimmer TSV, Megagen Anyridge, Biohorizon Internal, Bego Semados, etc.
 M1.6*P0.35	Pink	Straumann Bone level, Osstem GS Mini, Nobel biocare Active Mini, Dentsply Xive, Neodent GM, etc.
 M1.4*P0.30	Sky Blue	Starumann Bone level 2.9, Dio UF Narrow, Megagen Mini, Astra YellowMost of Multi unit, etc.
 M2.5*P0.45	Ivory	Osstem US Wide, Nobel biocare Branemark WP, etc.

** Please aware of the color of tips.
** Contact us for a complete list of implant compatibility.

Torque Adapter

Torque	0.4 Nm
--------	--------

WE SHARE THE EXPERIENCE
with
PERFECTION

GET IN TOUCH

Arum 3D Solutions Ltd.

+44 (0)207 388 1390



Scan for whatsapp!